

Power to Air-transportation via Hydrogen

Alireza Soroudi, Soheil Jafari

Abstract—This paper proposes a framework to analyze the concept of power to hydrogen (P2H) for fueling the next generation of aircraft. The impact of introducing new P2H loads is investigated from different aspects namely, cost, carbon emission, and wind curtailment. The newly introduced electric load is calculated based on the idea of replacing the busiest international flight route in the Europe, Dublin-London Heathrow, by hydrogen fuel-powered aircraft as a high potential candidate for the next generation of air travel systems to cope with the ambitious targets set in Europe Flight Path 2050 by the Advisory Council for Aeronautics Research in Europe (ACARE). The simulation is performed on a representative Irish transmission network to demonstrate the effectiveness of the proposed solution.

Index Terms—Power to gas, Transportation, Hydrogen fuel-powered aircraft, ACARE, Flight Path 2050

NOMENCLATURE

Constants

γ	Aircraft fuel burn per journey
Λ_b^W	Capacity of wind turbine in bus b
λ_D	load shedding cost coefficient
λ_e	Emission cost coefficient
λ_W	Wind curtailment cost coefficient
τ_t	Duration of period t (hours)
Ξ	Price of investment for P2H plant (€/MW)
ζ_b	0/1 parameter indicating if P2H plant exists in bus b
a_g, b_g, c_g	Thermal power cost coefficients
B_{bi}	Susceptance of line between bus b and i
D_f	Daily aircraft fuel burn
d_t	Demand at time t
D_{H_2}	Daily hydrogen demand
FHV	Fuel Heat Value
N_f	Number of flights per day
N_s	Average number of seats per aircraft
N_s	Average seats per aircraft
$P_{b,t}^L$	Electric demand in bus b at time t
P_{cos}	Carbon offsetting cost
P_{ef}	Equivalent jet fuel cost (€/MWh)
P_f	Jet fuel cost
RD_g	Ramp down of thermal generator g
RU_g	Ramp up of thermal generator g
w_t	Wind power availability at time t

Variables

$\delta_{i,t}$	Angle of bus i at time t
ξ	Capacity of P2H plant (MW)

C_e	Emission cost
C_f	Fuel cost
$c_{g,t}$	Fuel cost of unit g at time t
C_{lsh}	Load shedding cost
C_{P2H}	Investment cost for P2H plant
C_{wc}	Wind curtailment cost
$P_{bi,t}^\ell$	Power flow in line ℓ at time t
$P_{b,t}^C$	Wind curtailment at bus b and time t
$P_{g,t}^G$	Power of thermal generator g at time t
$P_{b,t}^W$	Power of wind turbine in bus b at time t
$P_{b,t}^{SH}$	Active load shedding at bus b and time t
Pch_t	Extracted power from the grid to produce H_2 at t
SOC_t	State of charge in H_2 storage at t
$Pdch_t$	Discharged power from H_2 storage at t

Sets and Indices

Ω_B	Set of network buses
Ω_D	Set of time steps in day D
Ω_G	Set of thermal generating units
Ω_k	Set of segments for linearizing the cost function
Ω_L	Set of transmission lines

I. INTRODUCTION

The increased share of renewable energy resources specially non-synchronous technologies such as wind and solar power can create new technical challenges for the power system operators. These challenges include (but not limited to) uncertainty in generation output of RES technologies [1], stability issues due to low inertia [2] and voltage control requirements. The inertia problem is prominent for those countries which are weakly connected to their neighbors with AC interconnection links. As an example, a huge amount of wind is annually curtailed in Ireland due to several technical reasons such as transmission network constraints or stability issues. In 2018, the total wind dispatch down in republic of Ireland and Northern Ireland was 707 GWh [3]. The three main reasons are listed as follows:

- The transmission constraints are related to the thermal limits of transmission lines as well as the N-1 security requirements. Due to the geographical availability of the wind, most wind turbines are connected to the west and south-west of the country and this increases the chance of wind dispatch-down in Ireland.
- By increasing the penetration level of non-synchronous generations (such as wind turbines), the amount of injectable wind power to the grid is limited to avoid frequency control problems. The total on-line inertia in the system should be able to provide rapid frequency response in case of a disturbance. To keep the power system safe and secure it is vital to measure and limit the System Non-Synchronous Penetration (SNSP) [4].

Alireza Soroudi (alireza.soroudi@ucd.ie) is with the School of Electrical and Electronic Engineering, University College Dublin, Dublin 04, Ireland. The work of Alireza Soroudi has emanated from research supported (in part) by University College Dublin under the UCD Grant Number OBRSS-62184. Soheil Jafari (S.Jafari@cranfield.ac.uk) is with the Centre for Propulsion Engineering, School of Aerospace, Transport and Manufacturing (SATM), Cranfield University, Cranfield, UK.

- Even if the amount of available on-line inertia is sufficient, the ramp-rates of thermal generating units might be not enough to cope with the variations of wind generation and cause wind dispatch-down. The min power generation limit in conventional technologies is another reason for curtailing the available wind power.

Dispatching down the clean energy (and using fossil fuel based technologies) is not in line with the European goals for reducing the greenhouse gas emissions by at least 40% from 1990 levels [15]. Some approaches have been proposed in the literature to reduce the wind curtailment. These methods can be categorised into two main groups:

- Non-wire solutions: in these models, the system operator/regulator tries to use the existing assets and utilise them in a more efficient way [16]. For example, dynamic line rating [17], using distributed series power flow controllers [16] and novel control techniques [18].
- Asset building models: in these models, some transmission lines will be built or upgraded [19]. Investing in energy storage technologies [20] can be included in this group.

Building new assets has been the traditional way of answering technical challenges in energy sector. However, the difficulties in obtaining the public acceptance is a big challenge for the decision makers in energy sector. In this work, the focus is on improving the principals that the power system is operated based on them without the need for upgrading the transmission network. The H_2 production has been proposed in the literature to overcome mitigate sub-synchronous oscillation in wind power systems [21] and seasonal storage [22]. Some existing works in the literature are compared in Table I. The idea of using zero-emission Hydrogen (H_2) as an alternative for fossil fuels in transportation sector has received a great deal of attention recently. One of the main drivers for this transition is EU's energy and climate targets for 2030.

A. Hydrogen based airplanes

The aviation sector is one the fastest-growing polluters. forecasts claim that aviation emissions could double in the next three decades even with more fuel-efficient aircraft [23]. So, it is the time to think differently about revolutionary ideas to deal with this challenge. The idea of liquid hydrogen fuel-powered aircraft has been widely considered in recent years by well-known airlines and manufacturers [24].

Technical feasibility, safety, environmental compatibility, and economic viability of liquid hydrogen as an alternative fuel for the next generation of civil aircraft have been confirmed by European Union (EU) researchers from 34 institutions in collaboration with industrial partners like Airbus [25]. The energy density of hydrogen per unit mass is 2.8 times higher than traditional jet fuel. However, the main obstacle is to produce it in quantity from low-carbon energy sources such as wind or nuclear. If this bottle neck is addressed, the aircraft greenhouse gases will be reduced dramatically. This would be a game changer for aircraft manufacturers to meet the severe limitations set in Advisory

Council for Aviation Research and Innovation in Europe (ACARE) Flight Path 2050 (e.g. a 75 percent reduction in CO_2 emissions and a 90 percent reduction of NO_x emissions by 2050) [26].

The other advantage of using liquid hydrogen in aviation is its thermal management characteristics as one of the best coolants used in engineering applications. The design of new and next generation of aircraft engines are increasingly complex with higher demands on engines for thrust and power generation resulting in hotter fluids, higher components temperature and higher heat generation, which means critical thermal management issues. So, it is time to think differently about how thermal loads in modern gas turbine engines can be managed. The liquid hydrogen is a very high potential heat sink that could be used in the architecture of thermal management systems for aircraft propulsion [27]. This paper proposes the idea of converting green electricity to hydrogen and supply the fuel need for the next generation of airplanes as shown in Fig. 1. The research gaps are as follows:

- The SNSP impact on H_2 production is not properly investigated
- The energy requirements of future hydrogen based airplanes and their impacts on power systems should to be analysed.

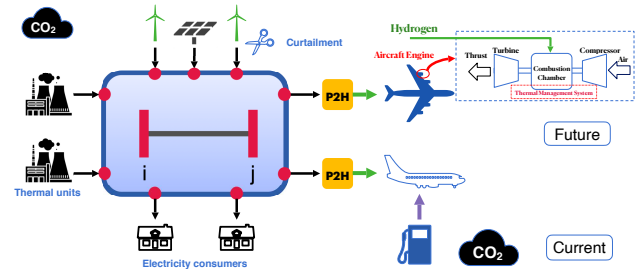

Fig. 1. Framework for future hydrogen based air-transportation

The following questions will be answered:

- How much energy do the next generation of airplanes need?
- How capable is the power system to supply those energy needs via green renewable resources?
- How power system-Air transportation nexus is achievable using the existing assets?

B. Contributions

An energy procurement model is proposed and formulated with the following properties:

- Proposing a linear model for procuring H_2 required for Air-transportation
- Considering the SNSP constraint for a system with high penetration level of non-synchronous generation
- Modeling the environmental impacts of aviation and electricity nexus.
- Modeling flight envelope's energy requirement.

TABLE I
LITERATURE REVIEW OF SOME EXISTING WORKS

Reference	Ship	Vehicle	Air transportation	Power flow constraints	SNSP	Device based	System	Distribution/Transmission
[5]		✓		No	No		Yes	NA
[6]		✓		AC	No		Yes	Distribution small scale
[7]		✓		No	No		Yes	Distribution small scale
[8]		✓		No	No	Yes		NA
[9]		General		Yes	No		Yes	Transmission
[10]		General		No	No		Yes	Distribution small scale
[11]		General		No	No	Yes		NA
[12]		General		No	No	Yes		NA
[13]	✓			No	No	No	No	NA
[14]		General		No	No	Yes		NA
Proposed model			✓	DC-OPF	Yes		Yes	Transmission-Large scale

C. Paper structure

The remainder of this paper is organized as follows: Section II presents the proposed model, as well as the main objective function and related constraints. In Section III the simulations are carried out on the Irish representative system and the numerical investigations are presented. Finally, the paper concludes in Section IV.

II. PROBLEM FORMULATION

This section of the paper provides the proposed formulation with the underlying assumptions.

A. Objective function

Objective function of the proposed algorithm includes operational costs, load shedding costs, wind curtailment cost and the annualized investment costs of P2H plants. The costs defined as the total costs should be minimized:

$$OF = C_f + C_e + C_{lsh} + C_{wc} + C_{P2H} \quad (1)$$

The different costs in (1) are defined as follows:

$$C_f = \sum_{g,t} \tau_t C_{g,t} \quad (2)$$

$$C_e = \sum_{g,t} \tau_t \lambda_e P_{g,t}^G \quad (3)$$

$$C_{lsh} = \sum_{b,t} \tau_t \lambda_D P_{b,t}^{SH} \quad (4)$$

$$C_{wc} = \sum_{b,t} \tau_t \lambda_W P_{b,t}^C \quad (5)$$

$$C_{P2H} = \xi \times \Xi \quad (6)$$

where $C_{g,t}$ is the fuel cost function (€/h), which is modeled by a quadratic function as follows.

$$C_{g,t} = a_g (P_{g,t}^G)^2 + b_g P_{g,t}^G + c_g \quad (7)$$

The non-linear fuel cost function in (7) will be replaced by set of equations as described in (8) [28]:

$$C_f = \sum_{g,t} C_{g,t} \quad (8a)$$

$$C_{g,t} = a_g (P_{g,t}^{min})^2 + b_g P_{g,t}^{min} + c_g + \sum_k s_g^k P_{g,t}^k \quad (8b)$$

$$s_g^k = \frac{C_{g,fin}^k - C_{g,ini}^k}{\Delta P_g^k} \quad (8c)$$

$$C_{g,ini}^k = a_g (P_{g,ini}^k)^2 + b_g P_{g,ini}^k + c_g \quad (8d)$$

$$C_{g,fin}^k = a_g (P_{g,fin}^k)^2 + b_g P_{g,fin}^k + c_g \quad (8e)$$

$$0 \leq P_{g,t}^k \leq \Delta P_g^k, \forall k \in \Omega_k \quad (8f)$$

$$\Delta P_g^k = \frac{P_g^{max} - P_g^{min}}{|\Omega_k|} \quad (8g)$$

$$P_{g,ini}^k = (k-1)\Delta P_g^k + P_g^{min} \quad (8h)$$

$$P_{g,fin}^k = \Delta P_g^k + P_{g,ini}^k \quad (8i)$$

$$P_{g,t}^G = P_g^{min} + \sum_k P_{g,t}^k \quad (8j)$$

The proposed linear formulation of the operating cost makes the problem scalable and suitable for realistic large power systems.

B. Constraints

The DC power flow equations and constraints of the system are as follows ($\forall t \in \Omega_T, \forall b, i \in \Omega_B$):

The nodal electric power balance for each time period is described as:

$$\sum_{g=1}^{\Omega_{G_b}} P_{g,t}^G + P_{b,t}^W - P_{b,t}^L + P_{b,t}^{SH} - Pch_t \times \zeta_b = \sum_{i=1}^{\Omega_B} P_{bi,t}^\ell \quad (9)$$

The power flow between each pair of connected buses (i.e. $b-i$) is calculated as:

$$P_{bi,t}^\ell = B_{bi}(\delta_{b,t} - \delta_{i,t}) \quad (10)$$

The satisfaction of ramp rate limits of the thermal units are ensured via the following constraints:

$$P_{g,t}^G - P_{g,t-1}^G \leq RU_g \quad (11)$$

$$P_{g,t-1}^G - P_{g,t}^G \leq RD_g \quad (12)$$

The hourly state of charge for hydrogen storage is dependant on the hourly charge/discharge as well as the efficiency factors.

$$SOC_t = SOC_{t-1} + (Pch_t - Pdch_t)\tau_t \quad (13)$$

The amount of hydrogen discharge depends on the capacity of the P2H plant (ξ).

$$Pdch_t \leq \xi \quad (14)$$

The total daily discharged hydrogen should be greater than the daily hydrogen demand for transportation (D_{H_2}).

$$\sum_{t \in \Omega_D} Pdch_t \geq D_{H_2} \quad (15)$$

where the following operating limits should be considered $\forall t \in \Omega_T$. The power output of thermal generating units should be kept within min and max values.

$$P_g^{min} \leq P_{g,t}^G \leq P_g^{max} \quad \forall g \in \Omega_G \quad (16)$$

The voltage angles of each bus should be kept within min and max values.

$$\delta_b^{min} \leq \delta_{b,t} \leq \delta_b^{max} \forall b \in \Omega_B \quad (17)$$

The power flow on each transmission line should be less than the thermal limit of that line.

$$-\bar{P}_{bi}^\ell \leq P_{bi,t}^\ell \leq \bar{P}_{bi}^\ell \forall \ell \in \Omega_L \quad (18)$$

The power output of wind turbines ($P_{b,t}^W$) are dependant on the wind availability of the region. The curtailed wind power is also limited to the wind availability and installed wind capacity.

$$0 \leq P_{b,t}^W \leq w_t \Lambda_b^W \quad \forall b \in \Omega_B \quad (19)$$

$$0 \leq P_{b,t}^C \leq w_t \Lambda_b^W - P_{b,t}^W \forall b \in \Omega_B \quad (20)$$

The variations of hourly electric demand (without the hydrogen demand) are assumed to be known as the input data:

$$P_{b,t}^L = d_t \bar{P}_b^L \forall b \in \Omega_B \quad (21)$$

The SNSP limit is enforced as follows:

$$\frac{\sum_b P_{b,t}^W + P_t^{import}}{\sum_b P_{b,t}^L + Pch_t + P_t^{export}} \leq SNSP \quad (22)$$

Considering the SNSP limit ensures the stability of the power system specially in the case of high wind power penetration.

C. Decision variables and input parameters

The decision variables are listed here:

$$DV = \left\{ \begin{array}{l} P_{g,t}^G, P_{b,t}^{SH}, P_{b,t}^W, P_{b,t}^C \\ \xi, Pch_t, Pdch_t, SOC_t \\ P_{bi,t}^\ell, \delta_{b,t} \end{array} \right\} \quad (23)$$

The input data for this problem are listed here:

$$Data = \left\{ \begin{array}{l} [a, b, c]_g, \lambda_e, \lambda_D, \lambda_W, \tau_t \\ B_{bi}, RU_g, RD_g, P_g^{min}, P_g^{max} \\ d_t, w_t, \Lambda_b^W, \bar{P}_b^L, D_{H_2} \end{array} \right\} \quad (24)$$

III. SIMULATION RESULTS

The proposed formulation is coded in GAMS [28] and the simulation results are discussed in this section.

A. Aircraft data

As a case study, the Dublin-London Heathrow route has been selected to analyse in this paper. The idea is to discuss the pros and cons of replacing aircraft flying in this route with liquid hydrogen powered ones. The statistical data for the top 20 busiest international air routes in the world is shown in Fig.2 and table II. Fig.2 shows the number of carried passengers (a), number of flights per year (b), flight duration (c), and on-time performance (OTP) (d) which refers to the level of success of the service remaining on the published schedule for each route. Table II also lists the routes in the first column (IATA codes of airports are used [29]) followed by number of carried passengers, air distance of each route, number of flights per year, the amount of produced passenger CO_2 /pax/leg, the duration of flight, average number of seats per aircraft, fuel burn per journey, and the OTP as an index for on time running. The data presented in this table is based on routes data in 2018 [30].

Fig.2 and table II, the trip between Dublin (DUB) and London Heathrow (LHR) is the busiest European entry with 14,390 flights per year according to OAG Aviation Worldwide Ltd report [30]. DUB-LHR route is also ranked 14th in the busiest routes of the world table. The average number of flights per day would then be 40. The flights are equipped with A318, A319, A320, and A321 aircraft. Based on the last update of the OAG report the average seats/aircraft for this route is 165 that could be accommodated in the above-mentioned aircraft (total number of seats is 2328652 and 1887170 passengers (Fig.2.a) were carried). In Fig.2, the size of the circles are proportional with the average flight time in each route. The Dublin-London Heathrow average flight time (hh:mm) is 01:33 (Fig.2.c) and the distance is 449 km. The details of different flight segments in the selected mission is presented in Fig.3. As it can be seen in this figure, the total fuel burn in the whole mission including taxi out, climb, cruise, descent, and taxi in phases is 2995 kg (Fig. 3). Therefore, according to International Civil Aviation Organization (ICAO) [31], the aircraft fuel burn per day could be calculated as follow:

$$D_f = N_f \times \gamma = 40 \times 2995 = 119.800ton \quad (25)$$

N_f is the number of flights per day, γ is Aircraft Fuel Burn/journey, and D_f is the Daily Aircraft Fuel Burn. The total value of fuel burn per day in Dublin-London Heathrow route is 119.8 tonnes. Moreover, A318, A319, A320, A321 have a Passenger CO_2 /pax/leg (KG) of 62.5 [31]. It means that the total amount of generated CO_2 per day is calculated as follows:

$$TCO_2 = \text{Passenger } CO_2/\text{pax/leg} \times N_s \times N_f \quad (26)$$

$$= 62.5 \times 165 \times 40 = 412.5tons$$

N_s is the average seats per aircraft.

Therefore, the Dublin-London Heathrow route is generating 412.5 tonnes of CO_2 per day. This emission could be cut

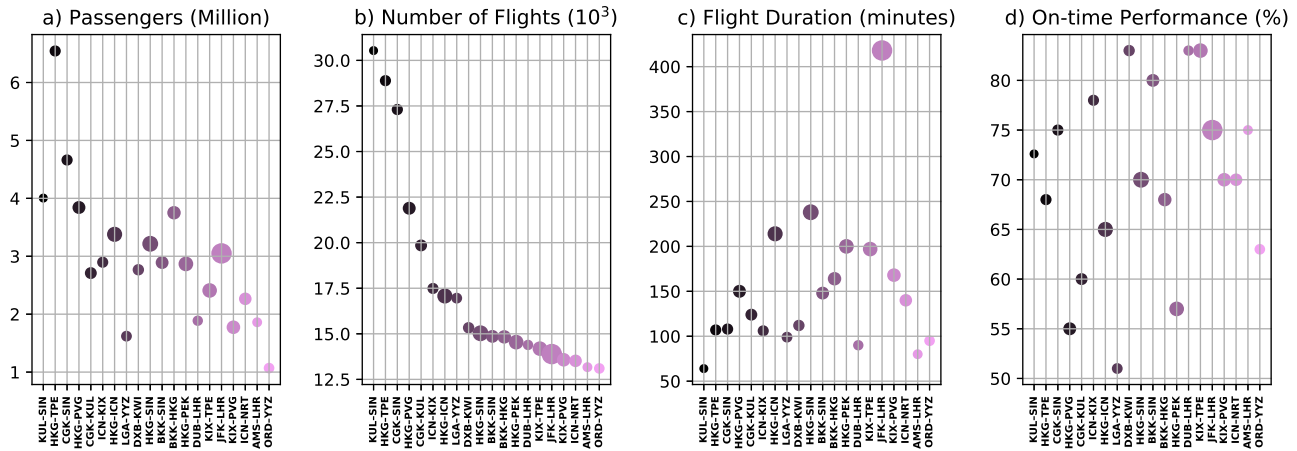

Fig. 2. Statistical data for top 20 busiest international air routes in the world. a) Number of passengers b) Number of flights c) Flight duration d) On-time performance

TABLE II
TOP 20 BUSIEST INTERNATIONAL AIR-ROUTES IN THE WORLD

#	Route	Passengers Million	Distance (Km)	Flights	CO_2 /pax/leg (kg)	Time (minutes)	Avg S/AC	Fuel /Journey (kg)	OTP (%)
1	KUL-SIN	4.00	296	30537	41.2	64	177	2766.3	72.6
2	HKG-TPE	6.54	805	28887	81	107	282	8799.7	68
3	CGK-SIN	4.66	880	27304	80.1	108	207	6328.1	75
4	HKG-PVG	3.84	1255	21888	113.5	150	226	9551.1	55
5	CGK-KUL	2.71	1127	19849	98.7	124	180	6197.1	60
6	ICN-KIX	2.9	859	17488	79.2	106	219	5905.6	78
7	HKG-ICN	3.38	2070	17075	154.1	214	254	14653.4	65
8	LGA-YYZ	1.62	571	16956	92.8	99	110	3108.6	51
9	DXB-KWI	2.77	851	15332	92	112	237	7283.5	83
10	HKG-SIN	3.22	2562	15029	172	238	272	23460.5	70
11	BKK-SIN	2.89	1416	14859	104.8	148	247	11461	80
12	BKK-HKG	3.75	1687	14832	127.7	164	318	15074.8	68
13	HKG-PEK	2.87	1989	14543	156.9	200	247	16225	57
14	DUB-LHR	1.89	449	14390	62.5	90	165	2995	83
15	KIX-TPE	2.41	1703	14186	138	197	225	12123.8	83
16	JFK-LHR	3.05	5536	13888	335.5	418	264	54216.9	75
17	KIX-PVG	1.77	1305	13576	114.5	168	174	8352.1	70
18	ICN-NRT	2.27	1255	13517	100.7	140	211	8834	70
19	AMS-LHR	1.86	365	13170	59.5	80	158	2620.2	75
20	ORD-YYZ	1.07	700	13100	115.6	95	95	2977.2	63

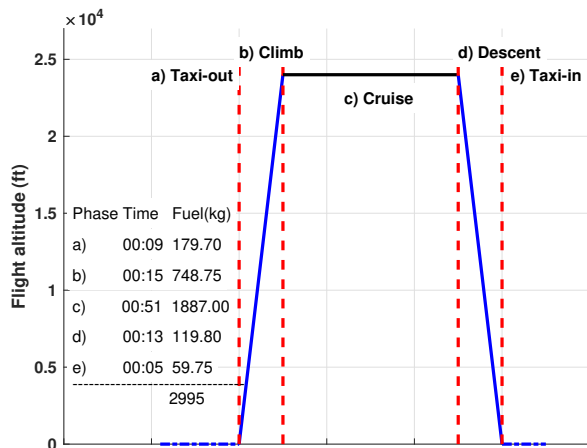

Fig. 3. Fuel consumption in each flight phase for DUB-LHR route

TABLE III
FUEL REQUIRED FOR DUBLIN-LONDON HEATHROW FLIGHTS PER DAY

Aircraft Type	N_f	FHV (MJ/kg)	γ (kg)	D_f (kg)
Jet Fuel Powered	40	43.1	2995	119800
Hydrogen Fuel Powered	40	120	1070	42785

with liquid hydrogen-powered aircraft subject to a feasible and affordable procedure of producing hydrogen fuel in quantity from a low-carbon sources. The heating value of liquid hydrogen is 2.8 times higher than jet fuel. Therefore, the daily need of the liquid hydrogen for the route is $119800/2.8 = 42.785$ tonnes. table III compares the required fuel for jet fuel powered aircraft with those of hydrogen fuel powered aircraft for the selected route per day.

The Clean Energy Partnership (CEP) states that producing hydrogen by electrolysis requires about 55 kWh/kg H_2 of electricity at an assumed rate of efficiency of higher than 60

TABLE IV
GENERATION DATA AND CONNECTION POINT

Generator	Cap (MW)	b	Generator	Cap (MW)	b
g_1	90	1	g_{17}	104	27
g_2	90	1	g_{18}	230	22
g_3	431	1	g_{19}	230	22
g_4	405	22	g_{20}	52	16
g_5	61	19	g_{21}	52	16
g_6	118	17	g_{22}	81	15
g_7	58	17	g_{23}	81	15
g_8	58	17	g_{24}	54	9
g_9	431	6	g_{25}	54	9
g_{10}	342	23	g_{26}	241	9
g_{11}	408	23	g_{27}	241	9
g_{12}	17	32	g_{28}	52	10
g_{13}	91	21	g_{29}	52	10
g_{14}	285	14	g_{30}	400	8
g_{15}	285	14	g_{31}	137	13
g_{16}	285	14	g_{32}	444	2

percent [32]. The daily required electric energy to produce the required liquid hydrogen for the busiest European route (Dublin-London-Heathrow) is: $D_{H_2} = 42785 \times 55 = 2353.1$ MWh. The investment cost (€) for P2H plant is assumed to be $\text{€}236000/\text{MW}$ [33].

B. Transmission network data

The transmission line data of Irish network is taken from [34] as shown in Fig.4.

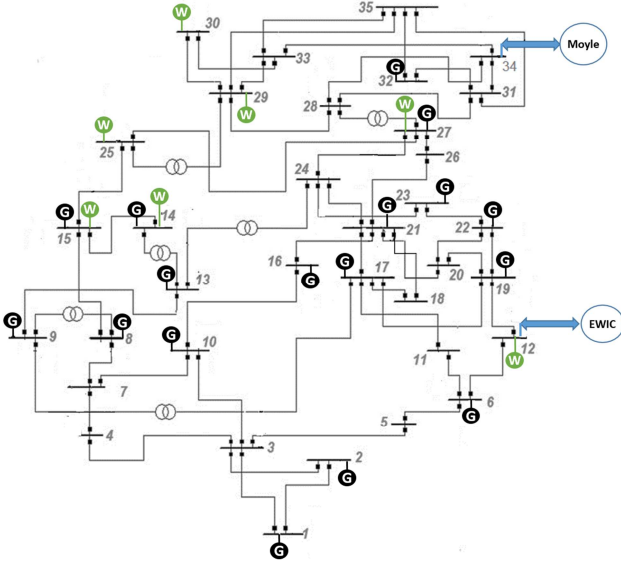

Fig. 4. Irish representative transmission network

The capacity of each conventional generating unit as well as the connection bus is specified in table IV. The peak values for the demand nodes are provided in table V. The peak demand for the whole network is 5400 MW. The SNSP is assumed to be 70%. It is assumed that there are 7 wind turbine sites in the network (with total installed capacity of 4200 MW). The installed capacity of each wind farm is given in table VI. For this study, the realistic demand, wind and import/export variation with time is taken from EirGrid [35] as shown in Fig. 5. The data is for 10 days (240 hours).

TABLE V
FORECASTED VALUES FOR PEAK DEMAND IN EACH BUS (MW).

b	\bar{P}_b^L	b	\bar{P}_b^L	b	\bar{P}_b^L
1	175.65	12	144.65	25	242.81
2	7.75	13	15.07	26	224.74
3	224.74	15	269.50	27	219.56
4	61.12	16	188.55	28	292.75
5	220.42	17	51.66	29	103.31
6	28.31	19	348.70	30	256.57
7	110.21	20	346.98	31	222.99
9	74.05	21	229.03	32	172.19
10	190.30	22	567.41	33	124.85
11	87.22	23	60.27	35	138.64

TABLE VI
INSTALLED CAPACITY OF WIND TURBINES IN EACH BUS (MW).

w_1	w_2	w_3	w_4	w_5	w_6	w_7
b=12	b=14	b=15	b=25	b=27	b=29	b=30
611	648	666	537	629	537	574

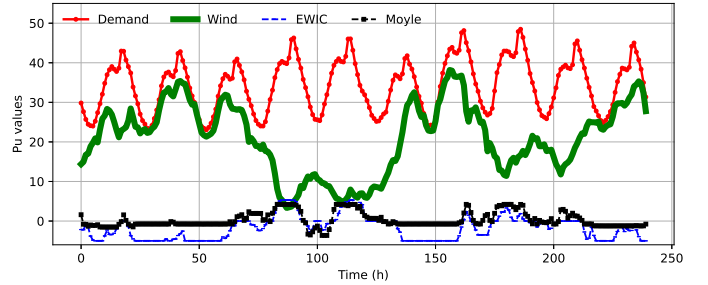

Fig. 5. Demand, wind and import/export variation with time

C. No P2H case

In this case, we assume that there is no P2H plant in the system. The daily quantities calculated in this case are:

- Daily Costs= $\text{€}6.910\text{M}$
- Daily WC= 4.1586 GWh.
- Daily CO_2 in power system= 14593.55 tons
- Daily CO_2 in aviation= 412.5 tones

D. Base case) P2H at Dublin airport

In this case, it is assumed that the P2H plant is installed at bus 22 (Dublin). The problem is solved and the simulation results show that

- Daily Costs= $\text{€}6.610\text{M}$
- Daily WC= 2.020 GWh
- Daily CO_2 in power system= 14697.84 tons
- Daily CO_2 in aviation= 0 tones

This means that we can have some saving by reducing the wind curtailment costs as well as 308.21 tons drop in total daily CO_2 pollution. The optimal size of the P2H power plant is $\xi = 504.255$ MW.

The hourly schedule of P2H for the base case is shown in Fig. 6 for some selected days. The optimal charge and discharge pattern of the hydrogen storage is depicted in this figure. The hourly variation of state of charge (SOC_t) shows the available amount of hydrogen at each time step. Whenever

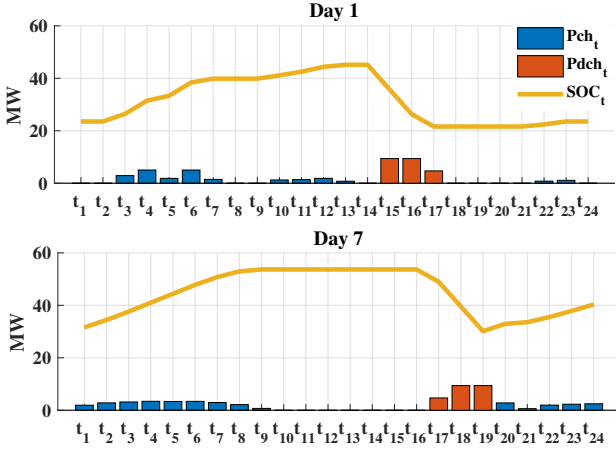

Fig. 6. P2H hourly schedule for base case for some selected days

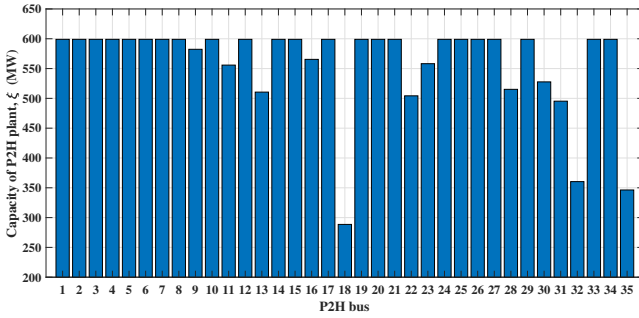

Fig. 7. Impact of P2H plant location on its optimal capacity

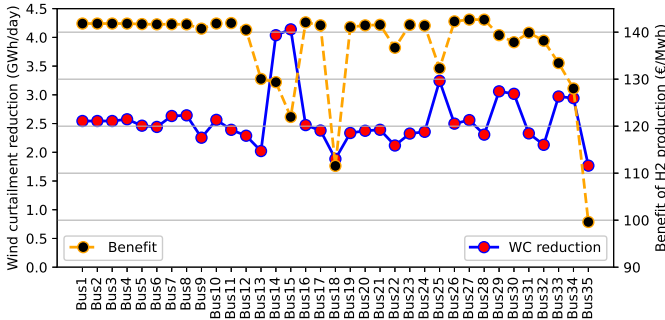

Fig. 8. Impact of P2H plant location on economic benefits and wind curtailments

the hydrogen storage is charged then the magnitude of SOC_t increases. The shapes of charging/discharging patterns are affected by electric demand, wind generation and network characteristics. For example, if a sufficient amount of wind is available in the network then the charging of hydrogen storage will begin.

E. Sensitivity analysis

1) *Connection point*: Assuming that there is only one P2H plant in the system, the connection point of P2H plant to the electricity grid is varied from bus 1 to bus 35. The optimal capacity of the P2H plant is determined in each case. The results are shown in Fig. 7. The minimum value of ξ is 288 MW at bus 18 and the maximum 600 MW on bus 15.

The price of producing H_2 is highly dependent on the location of the P2H plant as shown in Fig. 8. The benefit

of producing H_2 varies from 99.36 to 142.46 €/MWh. It means that producing H_2 is helping the system to avoid other costs (i.e. wind curtailment subsidies and environmental penalties). However, it should be noted that these numbers will not necessarily remain constant if the total daily required H_2 changes. It is worth considering that even the worst-case scenario in Fig. 8 (bus 35) would be much more beneficial compared to conventional jet fuel. The price of jet fuel, P_f , is around €0.5/kg [36]. Moreover, the carbon offsetting cost, P_{cos} , in different schemes would vary between €0.2/kg and €0.36/kg [37], [38]. Therefore, based on table III, the minimum and maximum equivalent jet fuel cost, P_{ef} , would be 25.45€/MWh (no carbon offsetting cost) and 43.86€/MWh (maximum carbon offsetting cost) respectively as described in (27). All scenarios in Fig. 8 will produce hydrogen fuel cheaper than jet fuel for the airliners.

$$P_{ef} = \frac{D_f(P_f + P_{cos})}{D_{H_2}} \quad (27)$$

P_{ef} is the equivalent jet fuel price per MWh, P_f is the fuel price, and P_{cos} is the carbon offsetting cost.

One of the factors that makes the P2H economically viable is the ability to absorb more wind to the electric network (and producing H_2). However, this capability in reducing the wind curtailment is highly dependant on the connection point of the P2H plant. Fig. 8 shows the Wind curtailment reduction (GWh) vs the connection point of the P2H plant. It varies between 1.767 GWh (bus 35) to 4.139 GWh (bus 15).

2) *SNSP level*: Finally, the impact of the SNSP level (22) is investigated on the total absorbed H_2 . For this purpose, the SNSP level is changed from 0.55 to 0.8. As depicted in Fig. 9, the SNSP level has a direct impact on total producible H_2 . This impact is different if the connection point of the P2H plant is changed in the network. For example, Bus 15 can absorb up to 7 times the daily required H_2 (2353.1 MWh) at a low SNSP level (0.55). It is expected to happen since at low SNSP levels, the total wind curtailment increases and it is more economic to convert it to hydrogen. This clearly demonstrates the importance of optimal allocation of P2H plant in the electricity network.

From Fig. 9 it is observed that increasing the SNSP beyond a certain level (here 75%) does not lead to increase in H_2 production or even reducing the operating costs. The technical reason behind this phenomena is that after certain SNSP level, the system can not absorb more power due to transmission line thermal limits. The min power generation limit of other non-res technologies can be also a reason for it.

3) *Selecting a pair of buses for P2H connection*: Increasing the number of P2H plants can improve the capability of the system in absorbing wind and therefore reducing the wind curtailment. The analysis shows that the best buses for pairing are $b_{15} - b_8$ which can reduce the initial average daily wind curtailment by 4.155 GWh. Both of these buses host wind turbines and therefore this combination has the potential to absorb more wind from the grid. The weight of edges in Fig. 10, shows the merit of each pair of buses for reducing the wind curtailment.

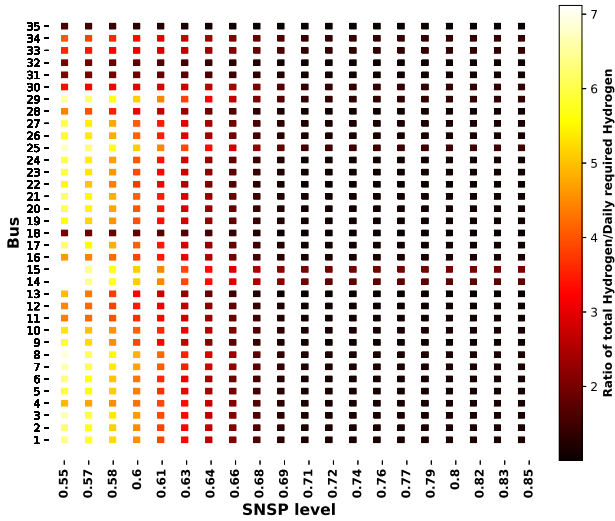

Fig. 9. Impact of SNSP level on capability of generating H_2

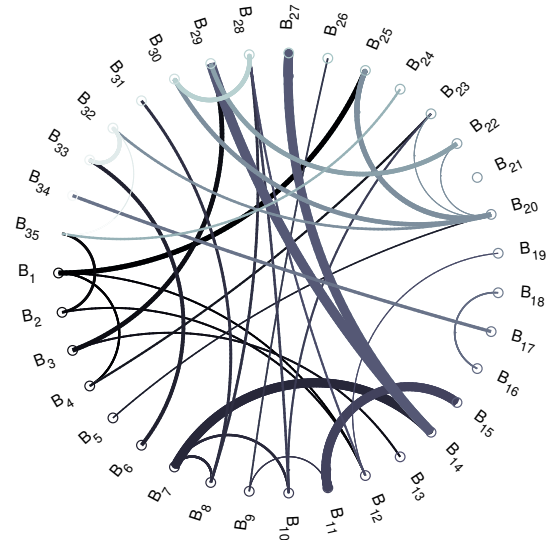

Fig. 11. Impact of pair-buses for connecting the P2H plants in reducing the operating costs

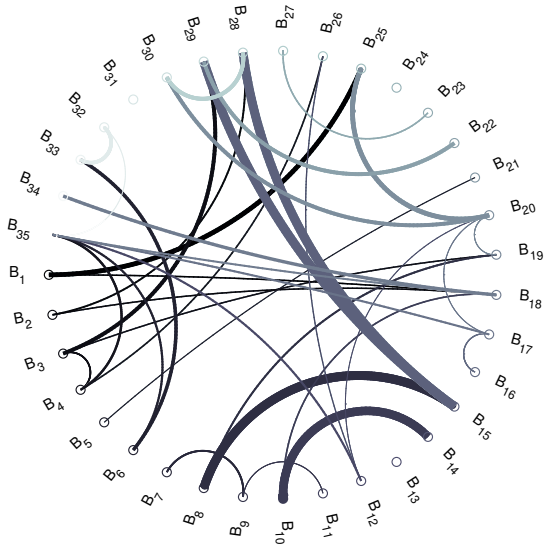

Fig. 10. Impact of pair-buses for connecting the P2H plants in reducing the wind curtailment

It should be noted that if the purpose of having two P2H plants is reducing the operating costs then the "best pair" might be different. Fig. 11 shows the best combination of the buses for reducing the operating costs. The best pair is $b_{14} - b_7$ which can reduce the daily operating costs (compared to No H_2 case) by €0.6261M.

F. Airlines' perspective

The possibility of having hydrogen fuel-powered civil aircraft (100+ passenger planes) is a game-changer for airlines; especially for dealing with the future targets and requirements of air travel systems (e.g. Flight Path 2050 [26]). The majority of a flight mission in civil aircraft is associated with the cruise phase at high altitudes where emissions have two to four times the impact of equivalent emissions at ground level.

Moreover, producing an alternative sustainable fuel in quantity with affordable prices in comparison with jet fuels is a strong motivation for aero-engine designers and manufacturers to invest and explore new designs for the next generation of aircraft engines respect to the limited supply and increasing price of the current jet fuels. In this aspect, electrification is also being considered as a high potential candidate. There are some successful projects in small battery-powered aircraft development [39], [40], [41]. However, the limitation of batteries' weight and low power to weight ratio means that it will be difficult to scale up to larger aircraft.

"With hydrogen as a fuel, there is no physical reason we can't go larger and longer. Each step in increasing the range and the size of aircraft we can fly needs technological improvements, but it's mostly a question of engineering, not new physics," Miftakhov, who previously founded an electric vehicle charging company eMotorWerks, said [42]. Although engine and aircraft manufacturers have to redesign the aircraft and engine, it is not a crucial point as it is what has happened every time a new engine is introduced.

IV. CONCLUSION

The main findings of this paper are outlined as follows:

- The connection point of the P2H plant as well as the size of it have significant impacts on the capability of P2H in absorbing electricity. This is mainly because of transmission network physical constraints (power flow and thermal line limits).
- By having P2H plants close to the wind sites, it would be easier to absorb the generated clean wind power and avoid violating the line flow limits.
- The environmental pollution penalty can make the P2H economically viable. The generated hydrogen can be either blended with the natural gas or combusted directly with nearly zero carbon emission.

- Producing the H_2 in high penetrated wind systems can be done at a negative price. The income obtained from selling the hydrogen and offsetting the carbon emission can return the operation and investment costs.
- Converting the excessive wind using the P2G can reduce the dependency rate on energy imports. It is inline with the stability improvement of EU's energy supply.
- The idea of producing green hydrogen could help the airliners in ACARE Flight Path 2050 emission requirements satisfaction as the aircraft greenhouse gases will be reduced dramatically. Using hydrogen ensures affordable transportation for all consumers by reducing the operating costs of airlines in the long run.

Suggestions for future work:

- The impact of H_2 extraction on gas networks should be investigated. A portion of the electricity demand will be supplied via thermal power plants. These generators are supplied by gas networks. The technical and economic set-points of gas networks will be affected [43].
- A more detailed AC-OPF can better characterize the impact of H_2 extraction in power systems.
- The voltage stability of power system in presence of H_2 extraction plants should be investigated [44]. The available transfer capacity of the system will be different in this case.
- The uncertainty of wind power generation should be taken into account to avoid financial and technical risks [45].

REFERENCES

- [1] S. M. Mohseni-Bonab and A. Rabiee, "Optimal reactive power dispatch: a review, and a new stochastic voltage stability constrained multi-objective model at the presence of uncertain wind power generation," *IET Generation, Transmission & Distribution*, vol. 11, no. 4, pp. 815–829, 2017.
- [2] M. Kheradmandi and R. Feuillet, "Using voltage control for reducing standing phase angle in power system restoration," *Electric Power Systems Research*, vol. 146, pp. 9–16, 2017.
- [3] S. EirGrid, "Annual renewable energy constraint and curtailment report 2018," 2019.
- [4] R. Kuwahata, P. Merk, T. Wakeyama, D. Pescia, S. Rabe, and S. Ichimura, "Renewables integration grid study for the 2030 japanese power system," *IET Renewable Power Generation*, 2020.
- [5] J. Mei, X. Wang, and J. L. Kirtley, "Optimal scheduling of real multi-carrier energy storage system with hydrogen-based vehicle applications," *IET Renewable Power Generation*, vol. 14, no. 3, pp. 381–388, 2020.
- [6] Y. Zhang and W. Wei, "Decentralised coordination control strategy of the pv generator, storage battery and hydrogen production unit in islanded ac microgrid," *IET Renewable Power Generation*, vol. 14, no. 6, pp. 1053–1062, 2020.
- [7] P. García-Triviño, J. P. Torreglosa, F. Jurado, and L. M. Fernández Ramírez, "Optimised operation of power sources of a pv/battery/hydrogen-powered hybrid charging station for electric and fuel cell vehicles," *IET Renewable Power Generation*, vol. 13, no. 16, pp. 3022–3032, 2019.
- [8] L. J. Kere, S. Kelouwani, K. Agbossou, and Y. Dubé, "Improving efficiency through adaptive internal model control of hydrogen-based genset used as a range extender for electric vehicles," *IEEE Transactions on Vehicular Technology*, vol. 66, no. 6, pp. 4716–4726, 2017.
- [9] P. Ge, Q. Hu, Q. Wu, X. Dou, Z. Wu, and Y. Ding, "Increasing operational flexibility of integrated energy systems by introducing power to hydrogen," *IET Renewable Power Generation*, vol. 14, no. 3, pp. 372–380, 2020.
- [10] H. Bakhtiar and R. A. Naghizadeh, "Multi-criteria optimal sizing of hybrid renewable energy systems including wind, photovoltaic, battery, and hydrogen storage with epsilon-constraint method," *IET Renewable Power Generation*, vol. 12, no. 8, pp. 883–892, 2018.
- [11] Q. Hu, J. Lin, Q. Zeng, C. Fu, and J. Li, "Optimal control of a hydrogen microgrid based on an experiment validated p2hh model," *IET Renewable Power Generation*, vol. 14, no. 3, pp. 364–371, 2020.
- [12] C. Brunetto and G. Tina, "Optimal hydrogen storage sizing for wind power plants in day ahead electricity market," *IET Renewable Power Generation*, vol. 1, no. 4, pp. 220–226, 2007.
- [13] M. Banaei, M. Rafiei, J. Boudjadar, and M. Khooban, "A comparative analysis of optimal operation scenarios in hybrid emission-free ferry ships," *IEEE Transactions on Transportation Electrification*, vol. 6, no. 1, pp. 318–333, 2020.
- [14] S. McDonagh, S. Ahmed, C. Desmond, and J. D. Murphy, "Hydrogen from offshore wind: Investor perspective on the profitability of a hybrid system including for curtailment," *Applied Energy*, vol. 265, p. 114732, 2020.
- [15] E. Commission, "National energy and climate plans (necps)," https://ec.europa.eu/clima/policies/strategies/2030_en, 2020.
- [16] A. Soroudi, P. Maghoul, and A. Keane, "Resiliency oriented integration of dsrs in transmission networks," *IET Generation, Transmission & Distribution*, vol. 11, no. 8, pp. 2013–2022, 2017.
- [17] K. Morozovska, "Dynamic rating with applications to renewable energy," Ph.D. dissertation, KTH Royal Institute of Technology, 2020.
- [18] Z. Dorevic, A. Durisic, "Mathematical model for the optimal determination of voltage level and pcc for large wind farms connection to transmission network," *IET Renewable Power Generation*, vol. 13, no. 12, pp. 2240–2250, 2019.
- [19] P. Maghoul and S. A. Mousavimirkolaei, "A transmission expansion planning model for maximizing merchant investment," *Journal of Electric Power & Energy Conversion Systems*, vol. 1, no. 1, pp. 8–15, 2016.
- [20] D. Yacar, D. A. Tejada-Arango, and S. Wogrin, "Storage allocation and investment optimisation for transmission-constrained networks considering losses and high renewable penetration," *IET Renewable Power Generation*, vol. 12, no. 16, pp. 1949–1956, 2018.
- [21] X. Xie, S. Wang, H. Liu, and Q. Zhao, "Hydrogen production equipment-based supplementary damping control to mitigate subsynchronous oscillation in wind power systems," *IET Renewable Power Generation*, vol. 13, no. 14, pp. 2715–2722, 2019.
- [22] P. Gabrielli, A. Poluzzi, G. J. Kramer, C. Spiers, M. Mazzotti, and M. Gazzani, "Seasonal energy storage for zero-emissions multi-energy systems via underground hydrogen storage," *Renewable and Sustainable Energy Reviews*, vol. 121, p. 109629, 2020.
- [23] D. Lee, "International aviation and the paris agreement temperature goals. unspecified. department for transport," 2018.
- [24] D. C. Maniaci, "Operational performance prediction of a hydrogen-fueled commercial transport," *2006 symposium paper Archived 2006-09-05 at the Wayback Machine*, 2006.
- [25] Airbus and Deutschland, in *Liquid Hydrogen Fuelled Aircraft - CRY-OPLANE Final Technical Report*, 2003.
- [26] M. Darecki, C. Edelstenne, T. Enders, E. Fernandez, P. Hartman, J. Hertenman, I. K. M. Kerkloh, P. Ky, and M. Mathieu, "Report of the high level group on aviation research, directorate-general for research and innovation directorate-general for mobility and transport," in *Flightpath 2050, Europe's Vision for Aviation Maintaining Global Leadership & Serving Society's Needs*, 2011.
- [27] S. Jafari and T. Nikolaidis, "Thermal management systems for civil aircraft engines: Review, challenges and exploring the future," *Applied Sciences*, vol. 8, no. 11, p. 2044, 2018.
- [28] A. Soroudi, *Power System Optimization Modeling in GAMS*. Springer International Publishing, 2017.
- [29] "Iata codes for airports," <https://www.world-airport-codes.com/>, 2019.
- [30] OAG and A. report, in *Key facts behind the world's 20 busiest routes*, 2018.
- [31] "International civil aviation organization icao carbon emissions calculator methodology," vol. Version 10, June 2017.
- [32] CEP, "Clean energy partnership," <http://cleanenergypartnership.de>, 2020.
- [33] Nrel, "Manufacturing cost analysis for proton exchange membrane water electrolyzers," <https://www.nrel.gov/docs/fy19osti/72740.pdf>, 2019.
- [34] D. J. Burke and M. J. O'Malley, "A study of optimal nonfirm wind capacity connection to congested transmission systems," *IEEE Transactions on Sustainable Energy*, vol. 2, no. 2, pp. 167–176, April 2011.
- [35] EirGrid, "Smart grid dashboard," <http://smartgriddashboard.eirgrid.com/>, 2020.
- [36] IATA, "Monitor, iata jet fuel price," <https://tinyurl.com/y75j3zft>, 2017.
- [37] Ontheluce, "The traveller's guide to carbon offsetting your flights," <https://www.ontheluce.com/carbon-offsetting-flights/>, Last updated on January 9, 2020.
- [38] Myclimate, "Offset your flight emissions," https://co2.myclimate.org/en/flight_calculators/new, 2020.

- [39] T. Hoggins, "The 'world's first' electric plane that can travel 650 miles on battery power alone," <https://www.telegraph.co.uk/technology/2019/06/21/worlds-first-electric-plane-can-travel-650-miles-battery-power/>, 21 June 2019.
- [40] U. Irfan, "Forget cars. we need electric airplanes." <https://www.vox.com/2019/3/1/18241489/electric-batteries-aircraft-climate-change>, 9 April 2019.
- [41] IATA, "The engineering marvels making planes greener," <https://tinyurl.com/vf5gteg>, 2020.
- [42] M. Scott, "Is hydrogen the fuel of the future for climate-friendly flying?" <https://tinyurl.com/wn4fbho>, 2020.
- [43] F. Sohrabi, F. Jabari, B. Mohammadi-Ivatloo, and A. Soroudi, "Coordination of interdependent natural gas and electricity systems based on information gap decision theory," *IET Generation, Transmission Distribution*, vol. 13, no. 15, pp. 3362–3369, 2019.
- [44] A. Rabiee, S. Nikkhah, and A. Soroudi, "Information gap decision theory to deal with long-term wind energy planning considering voltage stability," *Energy*, vol. 147, pp. 451–463, 2018.
- [45] M. Hemmati, B. Mohammadi-Ivatloo, and A. Soroudi, "Chapter 2 - uncertainty management in decision-making in power system operation," in *Decision Making Applications in Modern Power Systems*, S. H. A. Aleem], A. Y. Abdelaziz, A. F. Zobaa, and R. Bansal, Eds. Academic Press, 2020, pp. 41 – 62.